

# Electronics

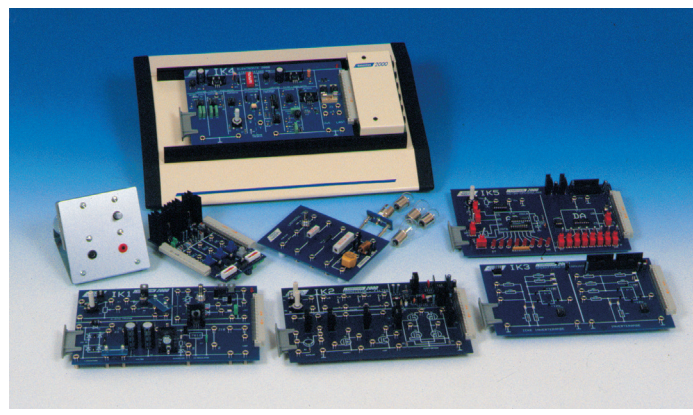

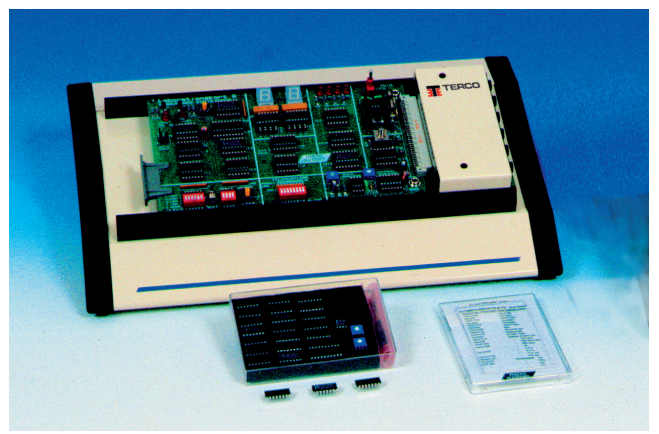
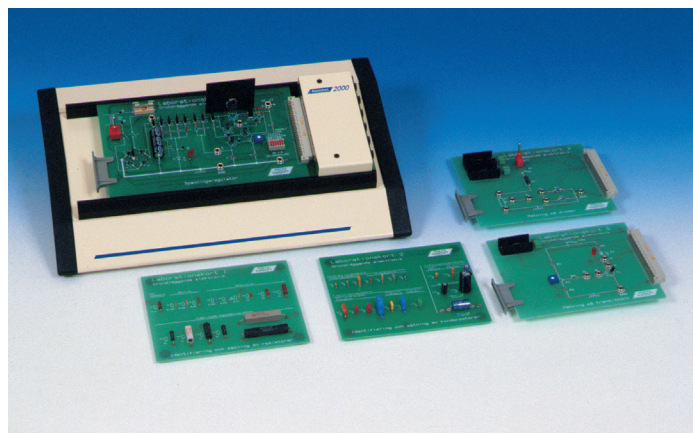

# Contents

Analogue Electronics-Basic.....	3-7
Digital Electronics - Basic.....	8-10
Power Electronics.....	11-15
Accessories & Instrument.....	16-17
Index.....	18

*Terco reserves the right to make changes in the design and modifications or improvements of the products at any time without incurring any obligations.*

## Analogue Electronics - Basic

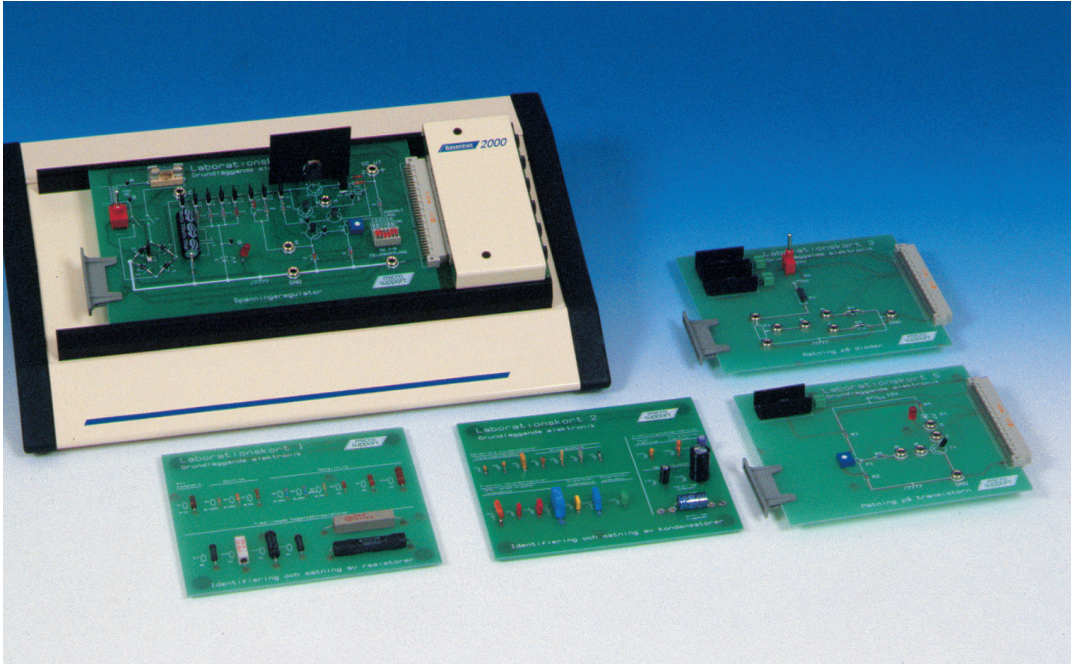

The course in Basic Analogue Electronics is an excellent introduction to electronics. The Laboratory Package consists of the Base Unit and five laboratory cards.

The Base Unit serves as a card holder and as a power supply with fuses for the laboratory cards. The Laboratory Package covers the basics in electronics, with special emphasis on the system method.

Laboratory card 4 is the most intricate and contains a power supply with which the student can learn the difference between component functions and to practice trouble shooting (fault finding), in order to get a better understanding of the system.

### TOPICS COVERED

Basic Electronics covers the following topics using the Lab Cards 1-5 as indicated in brackets:

- Identifying and measuring resistors (1) and capacitors (2)
- The diode (3)
- Full and half wave rectification (4)
- Filtering (4)
- Voltage stabilisation (4)
- The light emitting diode, LED (4)
- Transistor currents and voltages (5)
- Current amplification with transistors (4)
- The transistor as a regulating component (4)
- Current limitation (4)
- Fault detection (5)

The educational package in Basic Analogue Electronics includes a Laboratory Exercise Book. Every effort has been put into the layout and teaching methods.

The course objectives are:

- To understand the function of the components, identify them and connect them in simple circuits.
- To complete fault finding and to be able to use the measurement exercises using Lab Card 5.
- To complete a construction set which, after completing successive stages results in a DC voltage unit.





### ELE102000 Base Unit 2000

The Base Unit is used throughout the SYSTEM 2000. The unit supplies different output voltages suitable for the different lab cards used in the system. The Lab Cards put in slots and are automatically powered via a D-sub connector.

The base unit is accepted by CE standards.

#### Technical Data:

Supply voltage: 220 - 240V AC 50 - 60 Hz

The unit has 6 outputs with following data:

Output 1 - 3: DC 12 V / 3 A with LED indication and fuse

Output 4 - 6: AC 12 V / 3 A with LED indication and fuse

Dimension: 390 x 260 x 115 mm

Weight: 4 kg

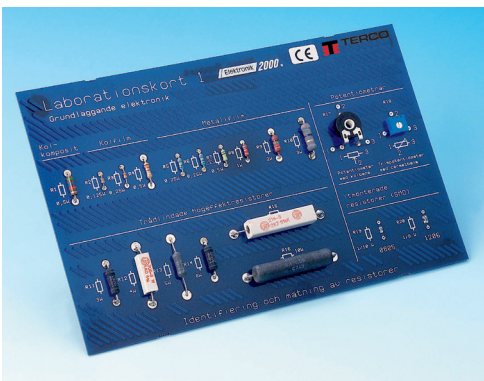

### ELE102010 Lab Card 1 Resistor

On Lab-card 1 there are 16 different hole mounted resistors, 2 potentiometers and 2 surface mounted (SMD) resistors.

With this card, measurement of components can be made, also recognition of values from the resistor code.

#### Technical Data:

Dimension: 220 x 140 x 10 mm

Weight: 0.1 kg

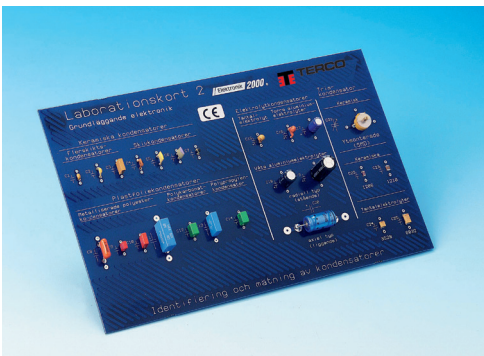

### ELE102020 Lab Card 2 Capacitors

On Lab card 2 there are 20 different hole mounted capacitors, 1 trimmng capacitor and 4 surface mounted (SMD) capacitors.

With this card measurement of components can be made, recognition of different types of capacitor.

#### Technical Data:

Dimension: 220 x140 x 20 mm

Weight: 0.1 kg

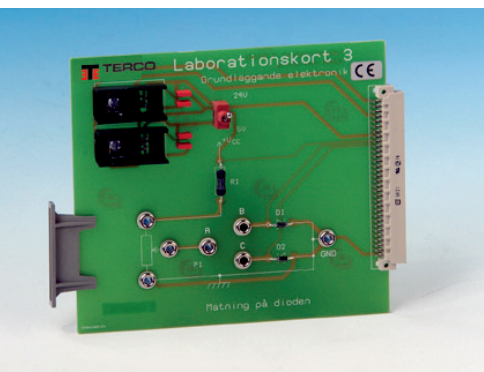

### ELE102030 Lab Card 3 Diodes

Lab card 3 is used for measurement and documentation of the characteristics of diodes. A variable resistor 100 ohm is required to complete the exercises.

#### Technical Data:

Dimension: 180 x140 x 30 mm

Weight: 0.1 kg

*Terco reserves the right to make changes in the design and modifications or improvements of the products at any time without incurring any obligations.*

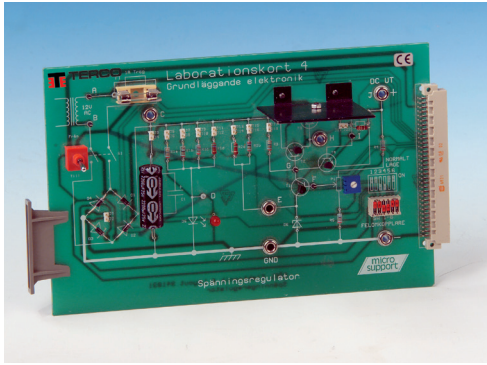

## ELE102040 Lab Card 4 Voltage Regulator

This is a stabilised DC voltage unit having different possibilities for connection. Measurement exercises include full and half wave rectifiers, zener diodes, light emitting diodes (LED's), transistors and electronic current limiters. There is also possibility to train in fault finding.

### Technical Data:

Variable output voltage approx.  
7-12V DC. 250 mA.  
Dimension: 240 x 140 x 30 mm  
Weight: 0.2 kg

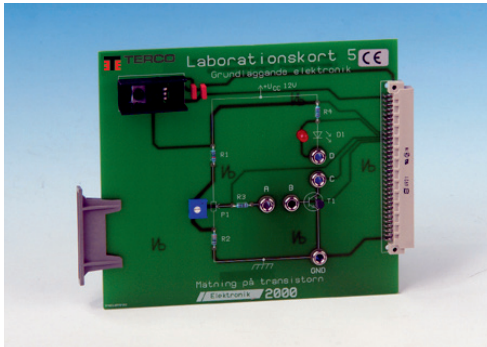

## ELE102050 Lab Card 5 Transistors

This card is used for measurement of the transistors current, voltage, power development, and function control.

### Technical Data:

Dimension: 180 x 140 x 25 mm  
Weight: 0.2 kg



## MV1955 Rheostat

The rheostat is enclosed in a robust metal case. The back, bottom and top of the case are perforated to provide optimum cooling. Two glass fuses protect the resistor against excessive current and incorrect connection. A scale having 100 divisions indicates the resistance setting.

### Technical Data:

Power 100W  
Resistance 100 Ohms  
Max Current 1 A  
Dimension: 140 x 130 x 145 mm  
Weight: 1 kg

## BOK112010 Electronic Basic Laboratory Exercise Book

Contents:

- Identification & measurement of resistors
- Identification & measurement of capacitors
- The diode
- Half wave rectifiers
- Filtering
- Full wave rectifiers
- Voltage stabilising with a Zener diode
- Light emitting diode (LED)
- Transistor, current and voltage amplification
- Current amplification with transistor
- Transistor as a regulator component
- Current limiters
- Function test
- Fault finding

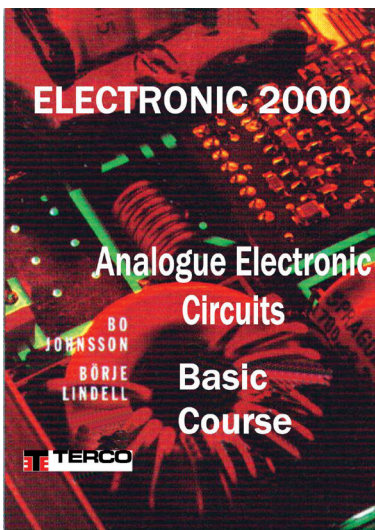

<b>ORDER DETAILS ANALOGUE ELECTRONICS</b>			
<b>Item</b>	<b>Description</b>	<b>Pcs</b>	<b>Page</b>
<b>Basic Analogue Electronics</b>			
ELE102000	Base Unit 2000	1	5,8,11
ELE102010	Lab Card 1 Resistor	1	5
ELE102020	Lab Card 2 Capacitors	1	5
ELE102030	Lab Card 3 Diodes	1	5
ELE102040	Lab Card 4 Voltage Regulator	1	6
ELE102050	Lab Card 5 Transistors	1	6
ELE102002	Storage Rack 1 row	1	16
MV1955	Rheostat 100 W 100 Ohm 1 A	1	6
STO170000	Lab Flex Set	1	16
<b>Books</b>			
BOK112010	Basic Electronics Laboratory Exercises	1	6
<b>Optional</b>			
XDO2040	Digital Oscilloscope, 2-Channel, 40 MHz	1	17
MX24B	Digital Multimeter TRMS (AC + DC)	2	17



## Digital Electronics - Basic

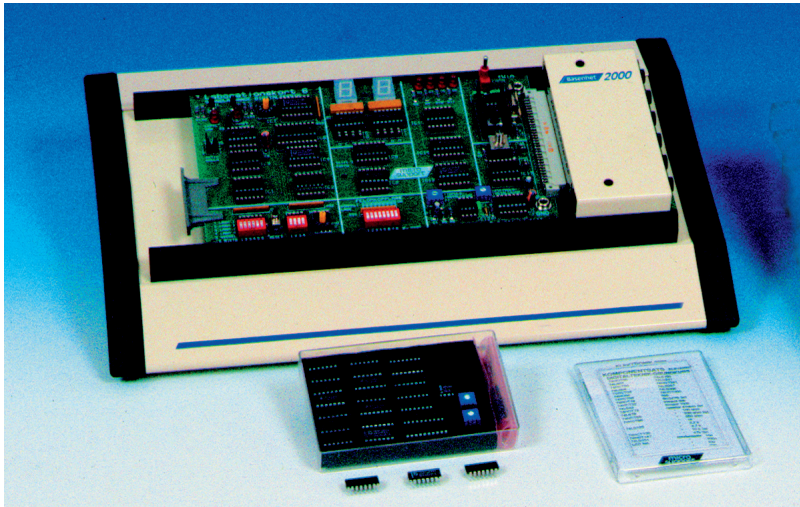

**Digital Electronics - Basic** deals with the basic logical elements, number system, combination circuits and switches. The practical exercises are carried out on the connection board and on a completed printed circuit board connected as a house alarm. Fault finding is also possible with the house alarm.

### TOPICS COVERED

Digital Electronics-Basic covers:

- The transistor as a switch
- The AND, OR, NOT, NAND, and NOR gates
- Logic families (S24), different types of outputs
- NAND synthesis
- Combinatory circuits
- XOR AND XNOR
- The comparator
- Decoder
- BCD Decoder and BCD to 7 segment decoder
- The demultiplexer
- Encoder (
- The multiplexer
- The Schmitt trigger
- Astable multivibrator (6) and monostable multivibrator
- The 555
- Bistable multivibrator
- D-multivibrator
- JK and T-multivibrator
- Registers
- Counters
- Fault detection



### ELE102000 Base Unit 2000

The Base Unit is used throughout the SYSTEM 2000. The unit supplies different output voltages suitable for the different lab cards used in the system. The Lab Cards put in slots and are automatically powered via a D-sub connector. The base unit is accepted by CE standards.

#### Technical Data:

Supply voltage:	220 - 240V AC 50 - 60 Hz
The unit has 6 outputs with following data:	
Output 1 - 3:	DC 12 V / 3 A with LED indication and fuse
Output 4 - 6:	AC 12 V / 3 A with LED indication and fuse
Dimension:	390 x 260 x 115 mm
Weight:	4 kg

*Terco reserves the right to make changes in the design and modifications or improvements of the products at any time without incurring any obligations.*



## BOK112030 Basic Digital Electronics Laboratory Exercises

8.27 In the diagram below G1 is used as a data input where  $G2A=G2B=L$ . How should A, B and C be set if the data at G1 shall be sent out on the lead connected to Y5?

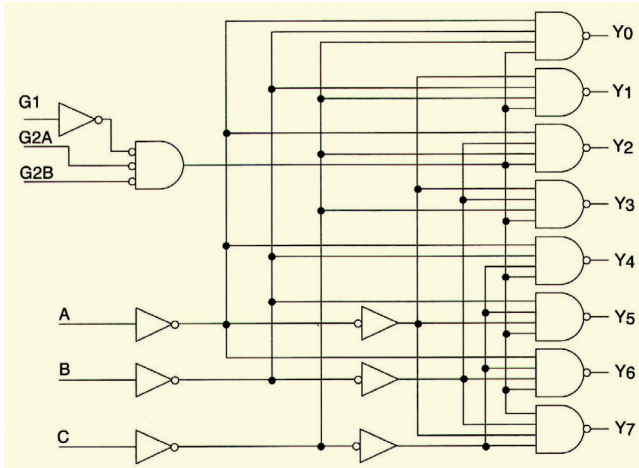

As can be seen in the diagram 9.15, an extra function has been added, LED that will indicate when the alarm is active. The LED has a self blinking action built into the circuit.

If the Base Unit is used, the lab-card shall be inserted into the contact plinth where it will receive the correct voltage supply.

- On the lab-card, measurements will be made on an alarm system constructed from digital circuits. First an easy alarm function and then additional functions as each circuit has been understood.
- Start by inserting the circuit 74HCT08 in the socket marked IC2 on lab card 6. If another card is already there, remove it temporarily.
- Remove the jumpers between sockets 1 and 2 at J3, with IC1 and IC2 as shown in 9.15. All connections are made on the card.

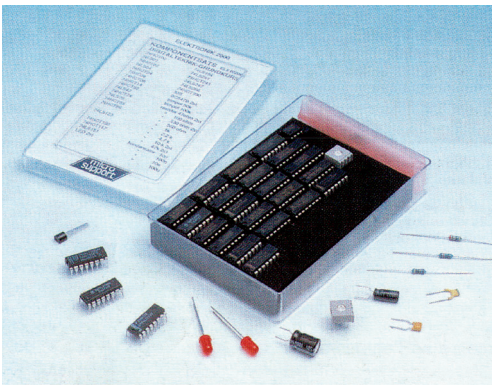
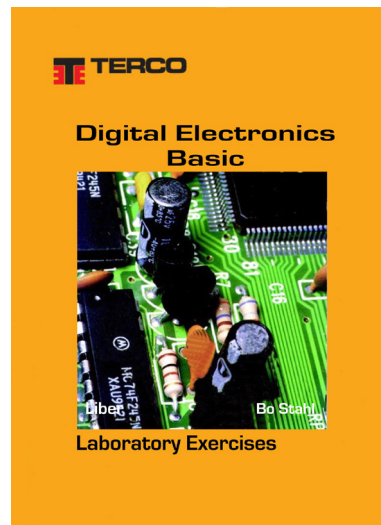

### ELE102065 Component Set DG1

The component set is delivered in a hard plastic box with ESD protection

#### Technical Data:

Digital IC	25	Trim potentiometers	2
Diodes	2	Resistors	13
Transistors	2	Capacitors	4
Dimension:	120 x 80 x 20 mm		
Weight:	0.1 kg		

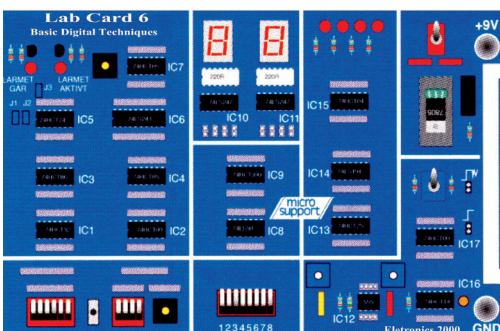

### ELE102060 Lab Card 6 House Alarm

Contains all the functions of a house alarm. The functions of an alarm system are learned step by step so making fault finding more easy to understand. Altogether 8 faults can be simulated. The alarm connections are built around normal digital components, e.g. logic gates, comparators, shift registers, counters, different types of switches and decoders. The lab card is connected to the Base Unit 2000.

#### Technical Data:

Dimension:	140 x 240 x 20 mm
Weight:	0.2 kg

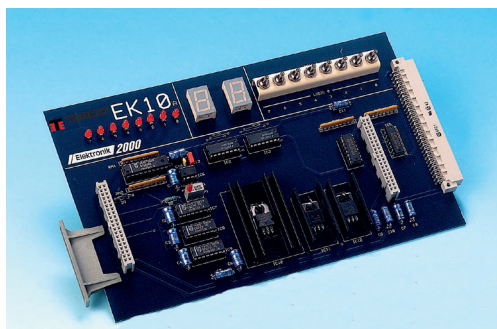

### XELE102010 EK10A Digital PCB

EK10A is a printed circuit board with similar functions as the S24 above. The lab card is connected to the Base Unit 2000 and is ordered separately.

#### Technical Data:

Dimension: 240 x 140 x 25 mm  
Weight: 0.3 kg

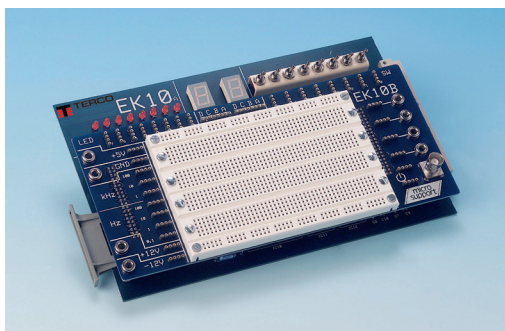

*EK10B Digital Plinth mounted on EK10A*

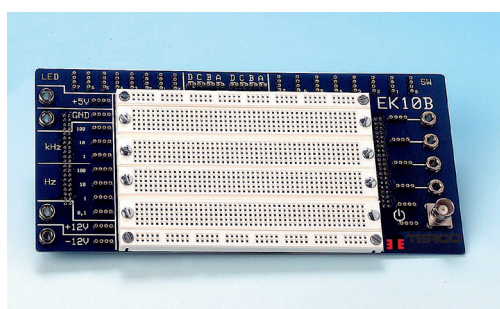

### XNOELE102110 EK10B Digital Connection Board for EK10A

This breadboard is easily connected to EK10A by means of 2 contact plugs. The board is suitable for projects where the student connects up circuits on EK10B and then connects this unit to EK10A for testing.

#### Technical Data:

Connection leads 4mm sockets: 4  
Connection lead BNC contact: 1  
Voltage outputs: (+5V, +12V, and -12V)  
Dimension: 220 x 100 x 30 mm  
Weight: 0.3 kg

### ORDER DETAILS DIGITAL ELECTRONICS

Item	Description	Pcs	Page
<b>Basic Digital Electronics</b>			
ELE102000	Base Unit 2000	1	5,8,11
ELE102060	Lab Card 6 House Alarm	1	9
ELE102065	Component Set DG1	1	9
XELE102010	EK 10 A Digital PCB	1	10
XNOELE102110	EK10B Digital Plinth for EK 10A	1	10
STO170000	Lab Flex Set	1	16
<b>Books</b>			
BOK112030	Basic Digital Electronics, Laboratory Exercises	1	9
<b>Optional</b>			
ELE102002	Storage Rack 1 row		16
XDO2040	GDS-1102A-U(CE) - Oscilloskop 2x100 MHz, 25 GS/s	1	17

## Power Electronics

Power Electronics is a very important field within the industry worldwide.

It is of utmost importance that students in the engineering branch have access to good laboratory equipment.

Within Power Electronics, Terco has a complete set of educational equipment, covering different components e.g. diode, thyristor, triac, diac, different transistors, amplifiers, etc., up to advanced AC- and DC drives.

Beyond the Basic Power Electronics Programme we present a package for traditional "Motor Control" covering Contactor Control, AC- and DC Converters, which also can be controlled by PLC.

Se catalogue: Basic Electricity and Motor Control

Besides our Power Electronics we have more advanced AC- and DC drives complete with motors, generators, loads etc.

Se catalogue: Electrical Machines Laboratory



### ELE102000 Base Unit 2000

The Base Unit is used throughout the SYSTEM 2000. The unit supplies different output voltages suitable for the different lab cards used in the system. The Lab Cards put in slots and are automatically powered via a D-sub connector. The base unit is accepted by CE standards.

#### Technical Data:

- Supply voltage: 220 - 240V AC 50 - 60 Hz
- The unit has 6 outputs with following data:
- Output 1 - 3: DC 12 V / 3 A with LED indication and fuse
- Output 4 - 6: AC 12 V / 3 A with LED indication and fuse
- Dimension: 390 x 260 x 115 mm
- Weight: 4 kg

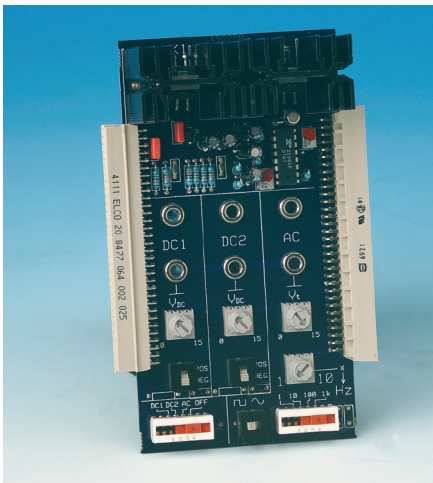

### ELE102001 Lab Card HK1 Help Function Card

The HK1 Help Function Card, serves as additional power supply and function generator.

The HK1 slots into the Base Unit 2000, and the Lab Card IK1 to 6 slots into HK1.

#### Technical data:

- DC Output 1: 0 - +15 V, (5 V/1.6 A 10V/1.0 A 15 V/0,1 A)
- DC Output 2: 0 - -15 V, (5 V/1.6 A 10V/1.0 A 15 V/0,1 A)
- Sinus wave: 1Hz to 10 kHz in 4 steps
- Square wave: 1Hz to 10 kHz in 4 steps
- Amplitude: 0-15 V / 8 Watt
- Size: 140 x 75 mm
- Weight: 0.2 kg

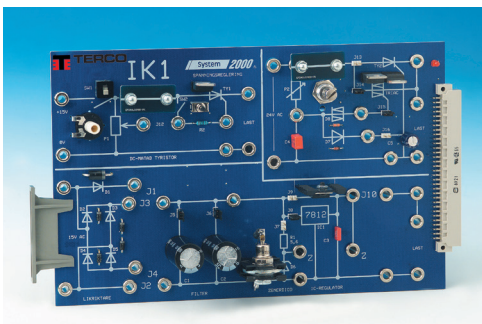

### ELE102221 Lab Card IK1 Power Regulator

The topics covered by Lab Card IK 1 Power Regulator, are the following exercises and experiments:

- Rectification, half bridge and full bridge
- Ripple Smoothing
- Voltage Stabilising with Zener Diode and IC
- Thyristor parameters
- Triac and Diac regulation with a lamp

#### Technical data:

- 4 mm panel sockets,
- Size: 220 x 140 mm, Weight: 0.2 kg
- Powered from Base Unit 2000 via connector.



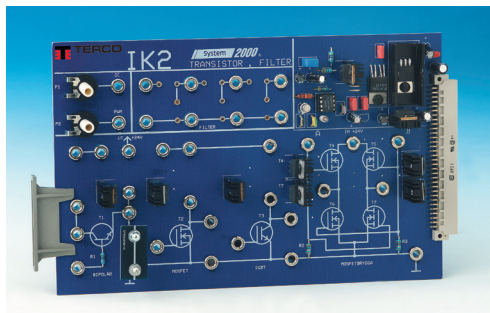

## ELE102222 Lab Card IK2 Transistors

The topics covered by Lab Card IK 2 Transistors, are the following exercises and experiments:

- Power Transistors
- Bipolar Transistor
- MOSFET
- MOSFET Bridge
- IGBT
- Filters

### Technical data:

- Output P1: DC 0 – 24 V
- Output P2: PWM Amplitude 24 V / Modulation 0 – 95% Powered from Base Unit 2000 via connector.
- 4 mm panel sockets
- Size: 220 x 140 mm
- Weight: 0.2 kg

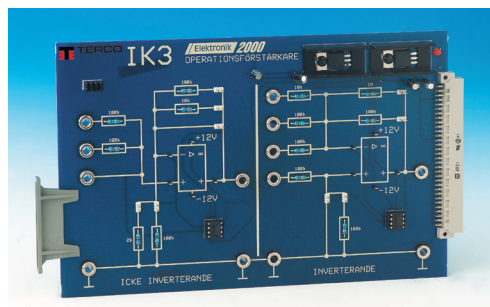

## ELE102223 Lab Card IK 3 Operational Amplifier

The topics covered by Lab Card IK 3 Operational Amplifier, are the following exercises and experiments:

- Operational Amplifier
- Voltage Follower
- Comparator
- Inverting Amplifier
- Non Inverting Amplifier
- Inverting Adder
- Non Inverting Adder
- Different Amplifiers

### Technical data:

4 mm panel sockets, Size: 220 x 140 mm, Weight: 0.2 kg  
Powered from Base Unit 2000 via connector.



## ELE102224 Lab Card IK4 Static Converter

The topics covered by Lab Card IK4 Static Converter, are the following exercises and experiments:

- Current Converter
- Fault finding
- DC Motor Drive
- Speed Control
- Opto Switch

Lab Card IK 4 will also be used together with the IK DC-Motor

### Technical data:

- 4 mm panel sockets
- Powered from Base Unit 2000 via connector
- Size: 220 x 140 mm
- Weight: 0.2 kg

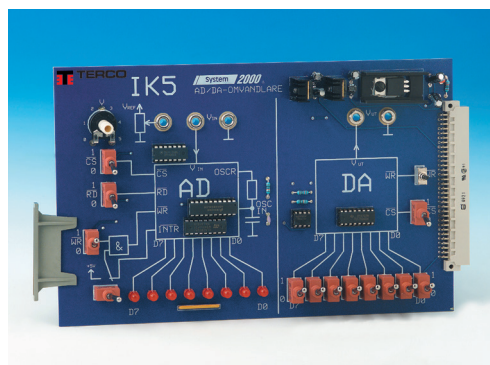

## ELE102225 Lab Card IK5 AD/DA Converter

The topics covered by Lab Card IK5 AD/DA Converter, are the following exercises and experiments.

- Resolution 8 bits
- AD/DA Converter Reference Voltage 5 V

### Technical data:

- 4 mm panel sockets
- Powered from Base Unit 2000 via connector
- Size: 220 x 140 mm
- Weight: 0.2 kg





### ELE102226 IK Component Set

This Load Module consists of potentiometer, resistors, inductor and lamp holder with four lamps.

Size: 100 x 140 mm  
Weight: 0.2 kg



### ELE102227 Lab Card IK DC-Motor for IK4

DC-Motor with tachometer generator and rpm meter. The motor can be connected to IK 4 Static Converter.

This DC-motor shall be slot into the Base Unit ELE102000 when doing experiments together with the Static Converter ELE102224 (DC-motor Drive). For these experiments two Base Units are needed.

**Technical data:**

- DC-Motor 24V / 10 W
- Size: 270 x 140 x 60 mm
- Weight: 0.5 kg



### ELE102228 Lab Card IK6 Frequency Converter

Lab Card IK6 Frequency Converter is a single phase frequency converter, to be used together with the IK AC-Motor.

It covers the following exercises and experiments.

- Frequency speed control of an AC-Motor
- Regulation
- Distortion
- Fault finding

**Technical data:**

- Output Voltage 12 V, 2 A
- Adjustable 10 – 90 Hz
- 4 mm panel sockets
- Powered from Base Unit 2000 via connector
- Size: 220 x 140 mm
- Weight: 0.2 kg



### ELE102229 Lab Card IK AC-Motor for IK6

AC-Motor with tachometer generator and rpm meter. The motor can be connected to IK 6 Frequency Converter.

This AC-motor shall be slot into the Base Unit ELE102000 when doing experiments together with the Frequency Converter ELE102228 (AC-motor Drive). For these experiments two Base Units are needed.

**Technical data:**

- AC-Motor 12 V / 10 W
- Size: 270 x 140 x 60 mm
- Weight: 0.5 kg

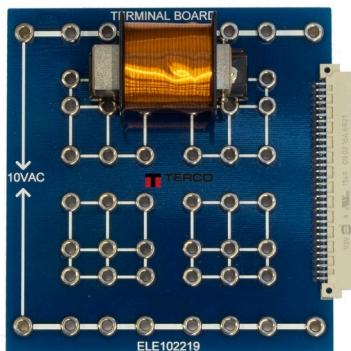

### ELE102219 Lab Card IK Terminal Bord

Used as coupling table for component connections and for calculating impedance (coil).

#### Technical data:

- 4 mm panel socket
- Size: 140 x 140 mm
- Weight: 0.4 kg

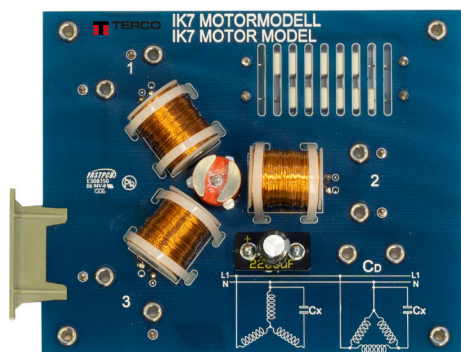

### ELE102220 Lab Card IK7 Motor Model

Used as control model together with Lab Card IK6 Frequency Converter.

#### Technical data:

- 4 mm panel sockets
- Size: 190 x 140 mm
- Weight: 0.4 kg

## BOK112050 Basic Power Electronics, Laboratory Exercises

#### Contents:

- Rectifications
- Smoothing
- Voltage Stabilising
- Thyristors
- Triac and Diac
- Transistors
- Filters
- Opto Switches
- Operation Amplifiers
- Static Current Converter
- AD/DA Transducers
- Measuring Semiconductors with a Digital Multimeter
- Measuring Components with an Oscilloscope
- Trouble shooting

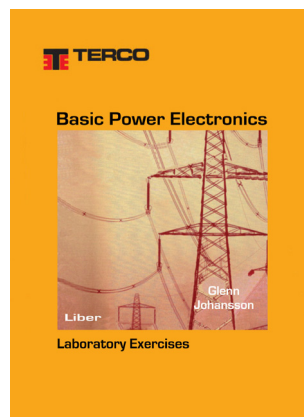

Measuring experiments may be performed with a voltage lower than 50 V when using equipment specified in this brochure. The fault searching training is done with help of the laboration card IK4.

#### After the course the student should be able to:

- Locate and write down PCB faults in an electronic system.
- Measure voltage and signals to and from circuit boards as applied in industrial- and/or power electronic systems.
- Interpret and use connection diagrams as they occur in electronic systems within production.
- Explain the principles of rectification, filtering and stabilization and perform simple trouble shooting in a power supply.
- Describe operation amplifiers and thyristor functions and their use in different industrial applications.
- Measure Semi-conductors with a Digital Multimeter.
- Measure Components with an Oscilloscope.

<b>ORDER DETAILS BASIC POWER ELECTRONICS</b>			
<b>Item</b>	<b>Description</b>	<b>Pcs</b>	<b>Page</b>
<b>Basic Power Electronics</b>			
ELE102000	Base Unit 2000	2	5,8,11
ELE102001	HK 1 Help Function Card	1	11
ELE102221	Lab Card IK1 Power Regulator	1	11
ELE102222	Lab Card IK2 Transistors	1	12
ELE102223	Lab Card IK3 Operational Amplifier	1	12
ELE102224	Lab Card IK4 Static Converter	1	12
ELE102225	Lab Card IK5 AD/DA Converter	1	12
ELE102226	IK Component Kit	1	13
ELE102227	IK DC-Motor	1	13
ELE102228	Lab Card IK6 Frequency Converter, AC	1	13
ELE102229	IK AC-Motor	1	13
ELE102219	IK Terminal Board	1	14
ELE102220	Motor Model IK7	1	14
ELE102004	Storage Rack 2 row	1	16
STO170000	Lab Flex Set	1	16
ELE102002	Storage Rack 1 row	1	16
<b>Books</b>			
BOK112050	Basic Power Electronics, Laboratory Exercises	1	15
<b>Optional</b>			
XDO2040	Oscilloskop 2x100 MHz, 25 GS/s	1	17
MX24B	Digital Multimeter TRMS (AC + DC)	1	17
MX58HD	Digital Multimeter TRMS Heavy Duty	1	17
MX1	Analogue Multimeter, moving coil	1	17
PX120	Digital Wattmeter TRMS three- and single phase	1	17

## Accessories



### ELE102002 Storage Rack 1 row

Storage rack for safe storage of the lab cards. It is constructed of hard plastic and very durable.

#### Technical Data:

Dimension: 355 x 180 x 180 mm  
Weight: 1.4 kg

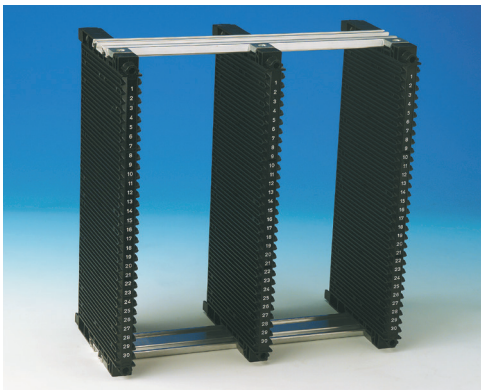

### ELE102004 IK Storage Rack

A system storage rack for IK 1 to IK 6 and HK 1. The storage rack will protect the Lab Card against electrical and mechanical damage.

Size: 340 x 180 x 355 mm  
Weight: 2 kg

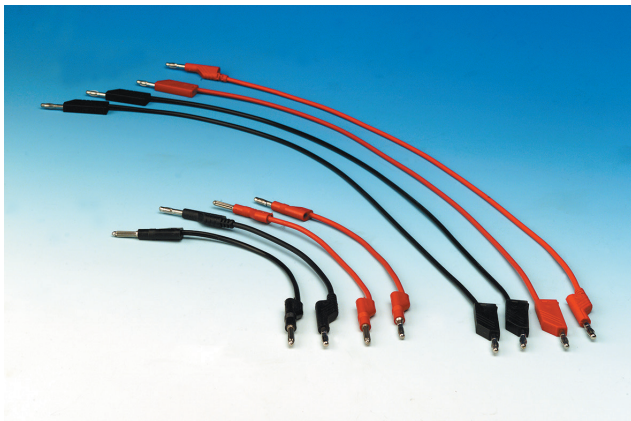

### STO170000 IK Sats med Labsladdar

This set contains all the cords needed for the laboratory work.

3 pcs red	25 cm	3 pcs red	50 cm
3 pcs black	25 cm	3 pcs black	50 cm
1 pcs Test Clip red		1 pcs Test Clip black	

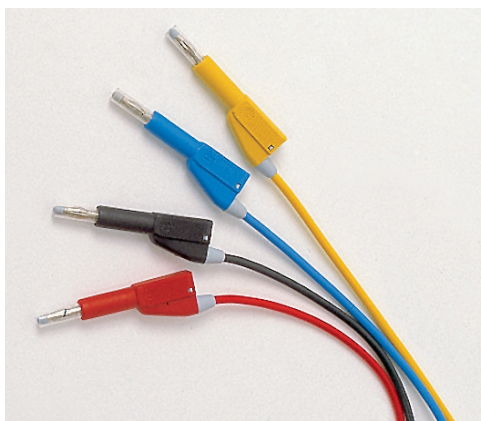

### MV1830-H Laboratory Flexes with Safety Plugs, Retractable Shroud

Set of 100 leads in 5 different colours, red, yellow, blue and yellow/green. 5 each of 4 different lengths, 25, 50, 100 and 200 cm.

Area: 1.5 mm<sup>2</sup>

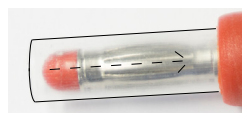

The pin is protected by a plastic sleeve when the flex is not connected. The plastic sleeve is pushed in to the flex when the plug is connected to the equipment.







**MX 24B Digital Multimeter**  
 20A ac 750V ac 20A dc  
 1000V dc



**MX1 Analogue Multimeter**  
 200A ac 1.5kV



**MX58HD Digital Multimeter**  
 10A ac 600V ac 10A dc  
 600V dc is not currently available



**F407 Digital Multifunction meter with logger.**  
 150 mA.....1000 AAC /  
 1500 A DC

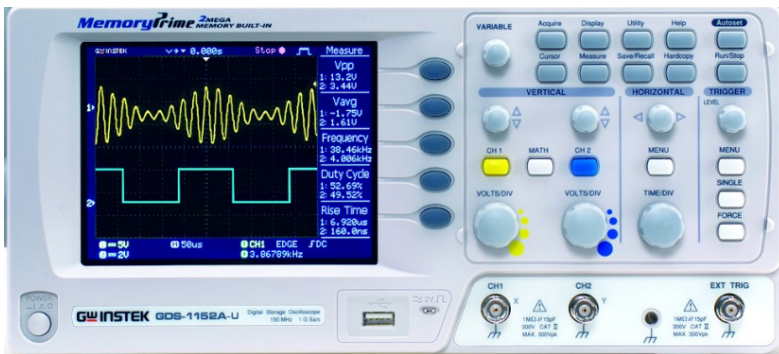

**GDS-1102A-U - Digital oscilloskop**  
 2 channels, 100 MHz, 1 GSPS, 2 Mpts, 3.5 ns

# Index

Item	Description	Page
BOK112010	Basic Electronics Laboratory Exercises	15
BOK112030	Basic Digital Electronics, Laboratory Exercises	9
BOK112050	Basic Power Electronics, Laboratory Exercises	15
ELE102000	Base Unit 2000	5,8,11
ELE102001	HK 1 Help Function Card	11
ELE102002	Storage Rack 1 row	16
ELE102004	Storage Rack 2 row	16
ELE102010	Lab Card 1 Resistor	5
ELE102020	Lab Card 2 Capacitors	5
ELE102030	Lab Card 3 Diodes	5
ELE102040	Lab Card 4 Voltage Regulator	6
ELE102050	Lab Card 5 Transistors	6
ELE102060	Lab Card 6 House Alarm	9
ELE102065	Component Set DG1	9
ELE102219	IK Terminal Board	14
ELE102220	Motor Model IK7	14
ELE102221	Lab Card IK1 Power Regulator	11
ELE102222	Lab Card IK2 Transistors	12
ELE102223	Lab Card IK3 Operational Amplifier	12
ELE102224	Lab Card IK4 Static Converter	12
ELE102225	Lab Card IK5 AD/DA Converter	12
ELE102226	IK Component Kit	13
ELE102227	IK DC-Motor	13
ELE102228	Lab Card IK6 Frequency Converter, AC	13
ELE102229	IK AC-Motor	13
MV1955	Rheostat 100 W 100 Ohm 1 A	6
MX1	Analogue Multimeter, moving coil	17
MX24B	Digital Multimeter TRMS (AC + DC)	17
MX58HD	Digital Multimeter TRMS Heavy Duty	17
PX120	Digital Wattmeter TRMS three- and single phase	17
STO170000	Lab Flex Set	16
XDO2040	Digital Oscilloscope, 2-Channel, 40 MHz	17
XELE102010	EK 10 A Digital PCB	10
XNOELE102110	EK10B Digital Plinth for EK 10A	10



# TERCO HEADOFFICE



Terco headoffice and factory outside Stockholm, Sweden



TERCO AB was founded in 1963 with the aim of producing and supplying practically oriented equipment for technical education.

TERCO develops, manufactures and markets advanced equipment and systems for technical education. TERCO is today represented in more than 50 countries world wide.

# TRAINING FOR TOMORROW'S WORLD



Power Systems

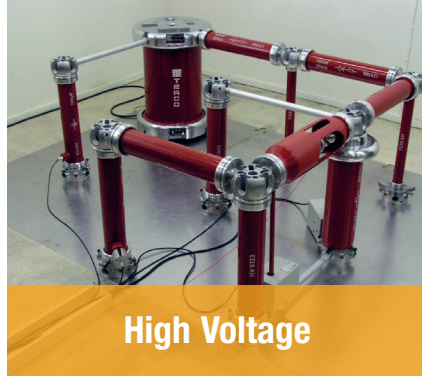

High Voltage



Electrical Machines & Drives



Mechatronics

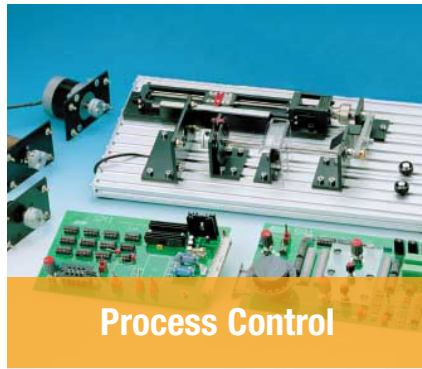

Process Control



Energy



Material Testing



Furniture & Power Distribution



Training

**TERCO AB**  
P.O. Box 5014  
SE-141 05 HUDDINGE  
SWEDEN

Office/Works: Pyramidbacken 6  
SE-141 75 KUNGENS KURVA  
STOCKHOLM

Phone: +46 8 506 855 00  
Fax: +46 8 506 855 01  
e-mail: [export@terco.se](mailto:export@terco.se)  
[www.terco.se](http://www.terco.se)

